



## FRANCES BAARD DISTRICT MUNICIPALITY

### INVITATION TO BID

#### **BID 19/24: DEMOLISHING OF EXISTING CARPORTS AT FRANCES BAARD DISTRICT MUNICIPALITY, DELIVER AND REBUILD AT THE JAN KEMPDORP FIRE STATION**

Frances Baard District Municipality (FBDM) hereby invites qualified service providers to submit proposals for the above-mentioned project.

This bid will be evaluated in terms of the 80/20 preference point system as prescribed in the Preferential Procurement Regulations, 2022 pertaining to the PPPF Act (No 5 of 2000) and the Supply Chain Management Policy of Frances Baard District Municipality. FBDM is not bound to accept the lowest bid. FBDM reserves the right to partial acceptance of one or more bids.

The closing date for submissions is 06 December 2024 at 12h00. Bids will be opened in public immediately after the stated closing time.

Proposals should be clearly marked: BID 19/24: DEMOLISHING OF EXISTING CARPORTS AT FRANCES BAARD DISTRICT MUNICIPALITY, DELIVER AND REBUILD AT THE JAN KEMPDORP FIRE STATION and submitted / delivered to The Municipal Manager (Ms. M. Bogatsu), Frances Baard District Municipal Offices, 51 Drakensberg Avenue, Carters Glen, Kimberley.

Bid documents are obtainable at FBDM's offices during working hours or on the FBDM Website ([www.francesbaard.gov.za](http://www.francesbaard.gov.za)). Enquiries on technicalities may be directed to Mr. C. Jones at tel. (053) 838 0925 and for supply chain matters to Mr. E. Tihageng at tel. (053) 838 0946 during office hours.

If no response is received in ninety (90) days after the closing date, consider your proposal unsuccessful.

**MUNICIPAL MANAGER**  
Ms. M. Bogatsu

# FRANCES BAARD DISTRICT MUNICIPALITY



## BID 19/24: DEMOLISHING OF EXISTING CARPORTS AT FRANCES BAARD DISTRICT MUNICIPALITY, DELIVER AND REBUILD AT THE JAN KEMPDORP FIRE STATION

**BIDDER:** .....

**ADDRESS:** .....

.....

.....

**TEL:** .....

**FAX:** .....

**BID AMOUNT (VAT Incl.)** .....

## **1. INTRODUCTION**

The services of a suitable service provider are needed to demolish existing carports at Frances Baard District Municipality; deliver and rebuild at the Jan Kempdorp fire station. The service provider must have a CIDB grading 1GB or higher. The project at the Jan Kempdorp fire station will be as follows:

- Cover the roof of the wash bay.
- Build three (3) carports, and
- Building a verandah over the existing double garage.

Bidders are advised to visit the site and satisfy themselves with the nature and extent of the work to be done. Bidders must take note that all materials left after the project stays as the property of FBDM.

## **2. Demolishing of existing carports**

The demolishing of the existing carports is on the property of the Frances Baard District Municipality, at 51 Drakensberg Avenue, Carters Glen, Kimberley. See attached sketches.

## **3. Location for the rebuilding of structures**

Jan Kempdorp Fire Station  
Erf 1106  
Piet Retief Street  
Jan Kempdorp.

## **4. Scope of work**

- Demolishing of existing structure.
- Transportation of demolished materials to Jan Kempdorp fire station.
- Cover the roof of the wash bay.
- Build three (3) carports.

- The building of a veranda over the existing double garage.
- Installation of gutters 200mm x 20mm (including two (2) offset pipes).
- Cleaning up of site after project is completed

**5. Sizes of structure to be demolished**

90m<sup>2</sup> the highest point of the structure of 5100mmm.

**6. Duration of project**

Project to be completed with two (2) months.

**7. List of material available from the structure to be demolished**

**6.1. Lip channels**

Size: 125mm x 50mm x 20mm	
Quantity	Length
04	4160mm
04	4380mm
03	10900mm
03	1435mm
Size: 225mm x 75mm x 20mm	
01	10900mm
01	14881mm
01	10123mm

**6.2. Square Tubing**

Size: 100mm x 100mm x 3mm	
Quantity	Length
01	4070mm
01	4123mm

02	4417mm
01	4739mm
01	4988mm
01	5097mm
01	4757mm
01	4407mm
01	4393mm
01	4746mm

### 6.3. Roof sheeting

Size: 0.5mm Cranked IBR roof sheets	
Quantity	Length
30	3800mm
07	11000mm
07	14000mm

## 7. Sizes of structures to be erected at Jan Kempdorp fire station

### 7.1. Cover wash bay area

Width	Length	Height
4700mm	8550mm	5355mm

### 7.2. Carports three (3)

Width	Length	Height
2500mm	5000mm	2500mm

### 7.3. Veranda over double garage

2700mm x 8000mm x 2500mm

Width	Length	Height
2700mm	8000mm	2500mm

## 8. Pricing schedule

Description	Cost
Cost to demolish existing structure at FBDM including the usage of scaffolding.	R.....
Transportation cost of demolished structure to Jan Kempdorp fire station.	R.....
Cost to erect new structures at Jan Kempdorp including the usage of scaffolding.	R.....
<b>Total excluding 15% Vat</b>	R.....
<b>15% Vat</b>	R.....
<b>Total including 15% Vat</b>	R.....

## 9. Bid proposed evaluation

The evaluation of this bid will be conducted in the following two stages.

Firstly, the assessment of functionality will be done in terms of the evaluation criteria and the minimum threshold. A bid will be disqualified if it fails to meet the minimum threshold for functionality as per the bid invitation.

Thereafter, only those qualifying bids will be evaluated in terms of the 80/20 preference points systems, where the 80 will be used for price **ONLY** and the 20 may be awarded to a tenderer for the specific goal specified for this tender.

Functionality criteria

CRITERIA	MAX POINTS (%)
<p>Relevant expertise and experience in steel construction roofs, carports.</p> <ul style="list-style-type: none"> <li>• Submission of three reference letters (20)</li> <li>• Submission of two reference letters (10)</li> <li>• Submission of one reference letter (5)</li> <li>• No reference letter (0)</li> </ul> <p>The duly signed reference letter with the client’s letterhead must indicate the company name, physical address, contactable person name and contact details (contact number / email address) that similar work was done by your company</p>	20
<p>Methodology</p> <ul style="list-style-type: none"> <li>• Addressing all key deliverables / outcomes (20)</li> <li>• Partially addressing key deliverables / outcomes (10)</li> <li>• Not addressing key deliverables / outcomes (0)</li> </ul>	20
<p>Work plan</p> <ul style="list-style-type: none"> <li>• Detailed plan (10)</li> <li>• Not detailed plan (5)</li> <li>• No plan (0)</li> </ul>	10

**NB:** A bidder that scores less than 30 points for functionality will be deemed non-compliant with the bid specifications.

### Evaluations criteria (price)

Only fixed prices for all deliverables will be accepted. The price should be inclusive of VAT.

<b>Price</b>	<b>80</b>
--------------	-----------

### Evaluations criteria (specific goals)

<b>Specific Goal</b>	<b>20</b>
----------------------	-----------

The objectives as specific goals in line with section 2(1) of the Act, is to:

(ii) Promote local labour and/ or promotion of enterprises located in the district municipal area of which 20 points is allocated, enterprises within Northern Cape outside the district municipal area 10 points and enterprises outside Northern Cape 5 points.

### **The 20 points will be allocated if a tenderer has the following proof;**

<b>Specific Goals</b>	<b>Points</b>	<b>Proof</b>
1. Enterprises located in the district municipal area.	20	Proof of residence. The following proof of residence will be acceptable for claiming: 1. Municipal Account. 2. Tribal Letter. 3. Lease agreement signed by landlord and the bidder.
2. Enterprises within Northern Cape outside the district municipal area.	10	
3. Enterprises outside Northern Cape	5	

### **Note:**

- A tenderer must submit proof for any specific goal as requested in order to claiming point(s) for that specific goal.
- A tenderer failing to submit proof with his quotation/tender may not be disqualified but will only score 0 points.

### **10. Statutory and general**

The following conditions will apply:

- Price quoted must be valid for ninety (90) days from date of your offer.
- Price quoted must be firm and must be inclusive of VAT.



- A firm delivery period must be indicated.
- Proof of municipal account.
- Proof of a summary report of central supplier database

This proposal will be evaluated in terms of the 80/20 preference point system as prescribed in the Preferential Procurement Regulations, 2022 pertaining to the PPPF Act (No 5 of 2000) and Supply Chain Management Policy of Frances Baard District Municipality (NB: MDB forms are obtainable at FBDM office during working hours as well as on the FBDM website: [www.francesbaard.gov.za](http://www.francesbaard.gov.za)):

- MBD 1 Invitation to bid
- MBD 3.1 Pricing schedules
- MBD 4 Declaration of interest
- MBD 6.1 Preference claim in terms of the Preferential Procurement Regulations
- MBD 7.2 Contract form
- MBD 8 Past Supply Chain management practice
- MBD 9 Certificate of independent bid determination

#### **11. Disqualification factors**

- **All bids that do not submit a valid tax clearance certificate / master registration number or tax compliance status PIN.**
- **All bids that do not submit a proposed methodology and detailed work plan.**
- **Failure to complete all required bid documents.**
- **Failure to submit proof of CIDB grading 1GB or higher.**
- **Terms and conditions that are not within this bid documents specifications / GCC**
- **All bids that are faxed, e-mailed or telegraphed.**
- **All bids that are received late.**

Frances Baard District Municipality reserves the right to accept a portion of a tender, and the lowest and/or any tender will not necessarily have to be accepted.

**The closing date for submissions is 06 December 2024 at 12h00. Proposals should be clearly marked: BID 19/24: DEMOLISHING OF EXISTING CARPORTS AND REBUILD AT THE JAN KEMPDORP FIRE STATION and submitted / delivered to The Municipal Manager (Ms. M. Bogatsu), Frances Baard District Municipal Offices: 51 Drakensberg Avenue, Carters Glen, Kimberley. For bid document enquiries, please contact the supply chain management unit (Mr. E. Tlhageng) at 053 - 838 0946 and for technical assistance Mr. C. Jones at 053 838 0925.**

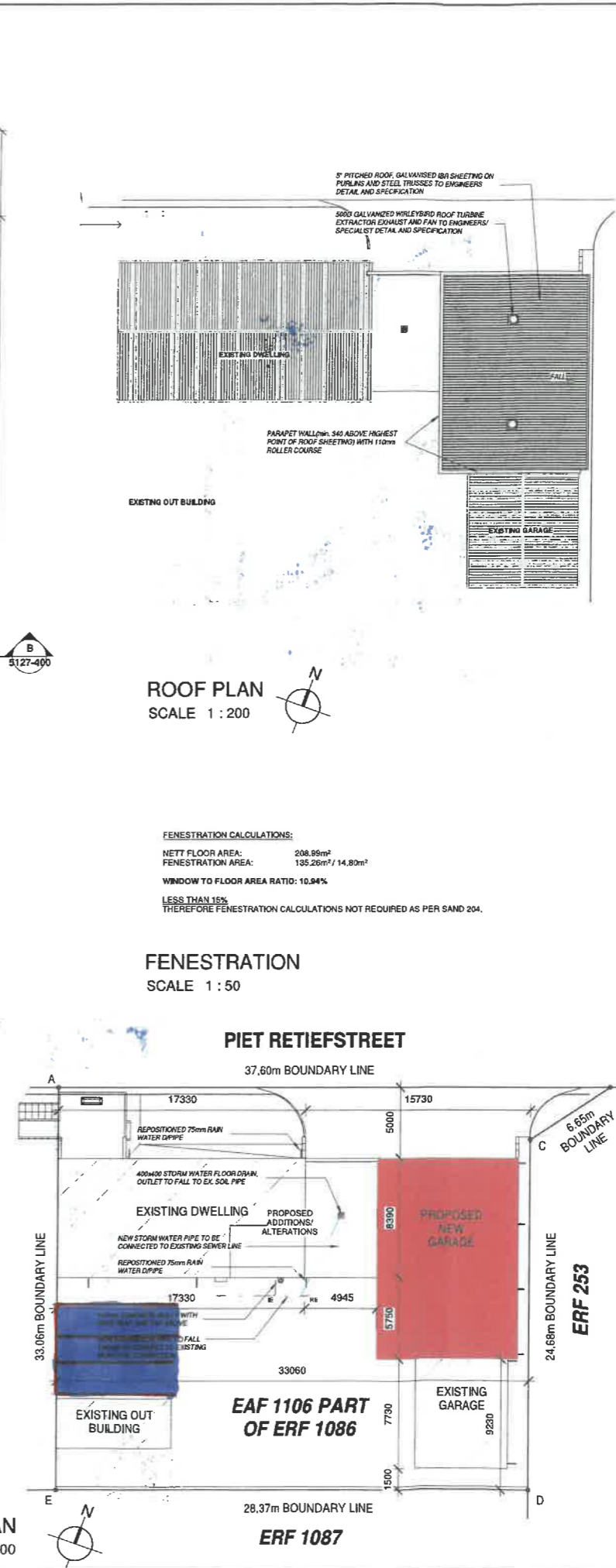
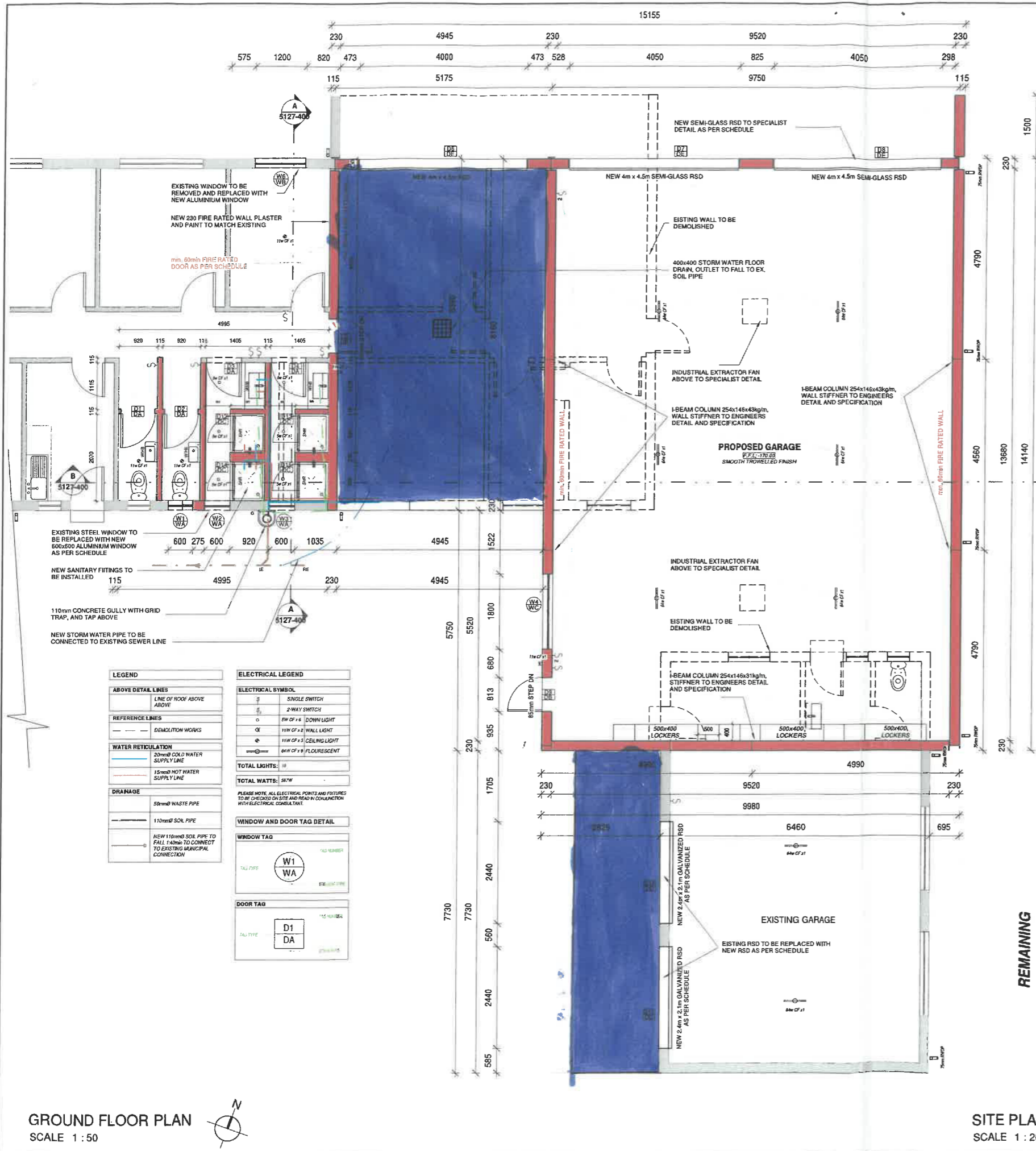

**NOTES:**

**GENERAL NOTES:**

THIS DRAWING IS NOT TO BE SCALED.  
PROVIDED DIMENSIONS TO BE USED AT ALL TIMES.  
CONTRACTOR IS RESPONSIBLE FOR CORRECT SETTING OUT OF THE BUILDING. ALL EXTERNAL AND INTERNAL WALLS WITH PARTICULAR REFERENCE TO BUILDING LINES, BOUNDARIES, ETC.  
CONTRACTOR TO VERIFY ALL LEVELS, HEIGHTS AND DIMENSIONS ON SITE AND TO CHECK SAME AGAINST THE DRAWING BEFORE PUTTING ANY WORK IN HAND.  
ALL CONTRACTORS TO CHECK DETAILS SHOWN ON THIS DRAWING FOR COMPLIANCE WITH STANDARDS OF GOOD BUILDING PRACTICE WITH PARTICULAR REFERENCE TO SPECIAL REQUIREMENTS SPECIFIED BY LOCAL AND OR ON SITE CONDITIONS AND REPORT ANY COMMENTS TO THE ARCHITECT.  
ANY ERROR DISCREPANCIES OR OMISSIONS TO BE REPORTED TO THE ARCHITECT IMMEDIATELY.  
FINAL DIMENSIONS TO BE TAKEN ON SITE BEFORE ORDERING, SUPPLYING AND FIXING PROPRIETARY OR RETAILED FITTINGS.  
CONTRACTORS ARE TO LOCATE AND VERIFY EXISTING SERVICES ON SITE AND TO PROTECT THESE FROM DAMAGE THROUGHOUT THE DURATION OF THE WORKS.  
CONTRACTORS ARE TO BUILD IN D.P.C.'S WHETHER OR NOT THESE ARE SHOWN ON DRAWINGS TO ALL EXTERNAL WALLS, AT EACH FLOOR AND TO ALL WINDOWS, DOORS OR OTHER OPENINGS IN EXTERNAL WALLS, CAVITY WALLS TO HAVE 25mm D.P.C.  
CONTRACTOR TO BUILD IN BRICK FORCE EVERY 5TH COURSE IN BRICK WALLS AND EVERY 2ND COURSE ABOVE WINDOWS, DOORS AND ALL OTHER OPENINGS.  
ALL GLAZING IN COMPLIANCE WITH SANS 10400 PART 1 LATEST EDITION.  
ANY QUERIES ARISING FROM ALL THE ABOVE MUST BE REPORTED TO THE ARCHITECT FOR CLARIFICATION BEFORE ANY WORK BEGINS ON HAND.  
QUALITY OF ALL MATERIALS AND WORKMANSHIP TO COMPLY WITH THE RELEVANT S.A.S. AND B.S. SPECIFICATIONS.

**DRAINAGE NOTES:**

ALL FLOORING AND DRAINAGE WORK AND INSTALLATION WORK SANITARY FITTINGS TO COMPLY WITH THE RELEVANT LOCAL AUTHORITY BY-LAWS, REGULATIONS AND REQUIREMENTS.  
ALL DRAIN PIPES: MINIMUM FALL 1:60, MAXIMUM FALL 1:10.  
ALL WASTE PIPES AND SOIL PIPES TO BE FULLY ACCESSIBLE ALONG ENTIRE LENGTH OF THE PIPE.  
I.E. TO BE PROVIDED AT EVERY BEND, JUNCTION AND CHANGE IN DIRECTION AND EVERY 24 METERS WITH MARVED COVERS AT GROUND LEVEL.  
ALL WASTE PIPE FITTINGS TO HAVE APPROVED RESEAL TRAPS.  
VENT PIPE OUTLET TO BE MIN. 2m ABOVE ANY OPENING.  
ALL BATH ENCLOSURES TO HAVE ACCESS PANELS.  
GULLIES TO BE TRAPPED AND WITH SUITABLE GULLY GRATING AND TO BE 150mm ABOVE SURROUNDING LEVELS.  
ALL DRAINS UNDER BUILDINGS OR FOOTINGS TO BE ENCASED IN 150mm CONCRETE ALL ROUND THE PIPE.  
WASTE PIPES IN FLOORS TO BE SLOPED AND BE FITTED WITH EASY ACCESSIBLE C.I.E. ABOVE FLOOR LEVEL AND EACH END OF SLAB.  
NO DRAIN BENDS OR JUNCTIONS IN OR UNDER FLOOR SLAB.  
KEEP ALL DRAINS 60mm FROM CONCRETE FOUNDATIONS.  
**ALL STRUCTURAL CONCRETE WORK TO ENGINEER'S DESIGN AND SPECIFICATION**

NO	REVISION	DATE

**AREA SCHEDULE**

AREA OF STAND:	PERMISSIBLE COVERAGE (50%):	948.12m <sup>2</sup>
		474.06m <sup>2</sup>
<b>PROPOSED NEW COVERAGE:</b>		
GROUND FLOOR EX. (TOTAL):	(223.32m <sup>2</sup> )	
MANN DWELLING:	145.39m <sup>2</sup>	
GARAGE:	49.93m <sup>2</sup>	
OUTBUILDING:	28.00m <sup>2</sup>	
GROUND FLOOR NEW. (TOTAL):	(141.11m <sup>2</sup> )	
FIRE ENGINE GARAGE:	141.11m <sup>2</sup>	
ADDITIONAL ALTERATIONS (IN MANN DWELLING):	19.46m <sup>2</sup>	
<b>TOTAL COVERAGE:</b>	<b>364.49m<sup>2</sup></b>	
<b>GROSS BUILDING AREA:</b>	<b>169.57m<sup>2</sup></b>	
<b>% COVERAGE:</b>	<b>38.43%</b>	

**AS BUILT**

**CLIENT**  
FRANCES BAARD  
DISTRICT MUNICIPALITY

**ENGINEER**  
L. LLOYD CONSULTING

**ARCHITECTURE | DESIGN | INNOVATION**  
**THE CREATIVE AXIS ARCHITECTS**  
92 Beyers Naude Avenue, Potchefstroom, 2531.  
PO Box 407, Potchefstroom, 2520  
Tel: +27 18 297 1725 Fax: +27 18 294 7360

**PROJECT**  
PROPOSED FIRE ENGINE GARAGES  
STD No. 1106 JAN KEMPDORP, PIET RETIEF STREET

**DRAWING**  
GROUND FLOOR PLAN, SITE PLAN, PLAN LEGEND, AREA SCHEDULE

**SCALE**  
As indicated

**DATE**  
2019-09-27

**DRAWN**  
N.J.

**CHECKED**  
Y.V.

**PROJECT NUMBER**  
NW5127

**DRAWING NUMBER**  
5127-200

**REVISION**

1:50 NORTH WEST PROJECTS\NW5127 - FRANCES BAARD DISTRICT MUNICIPALITY\SUBMISSION\FRANCES BAARD FIRE ENGINE GARAGES - AS BUILT.rvt

# JAN KEMPDORP FIRE STATION

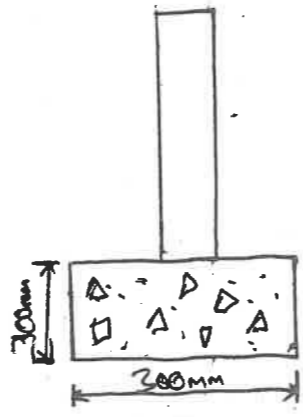
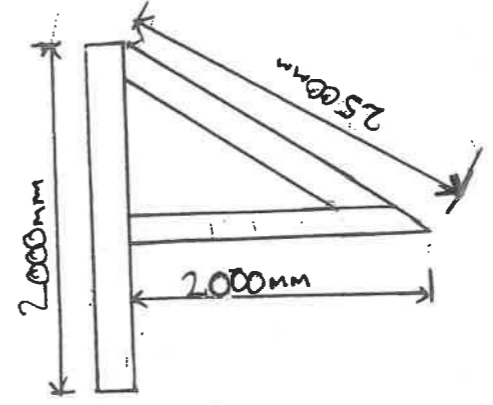
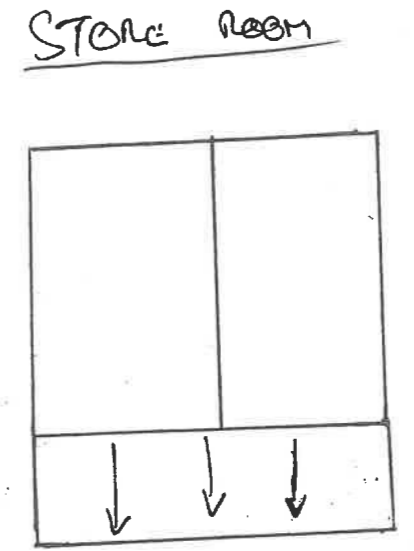
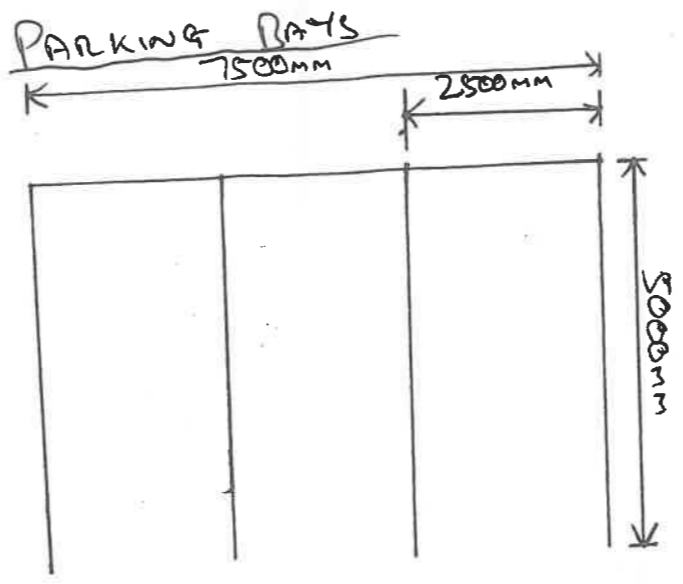
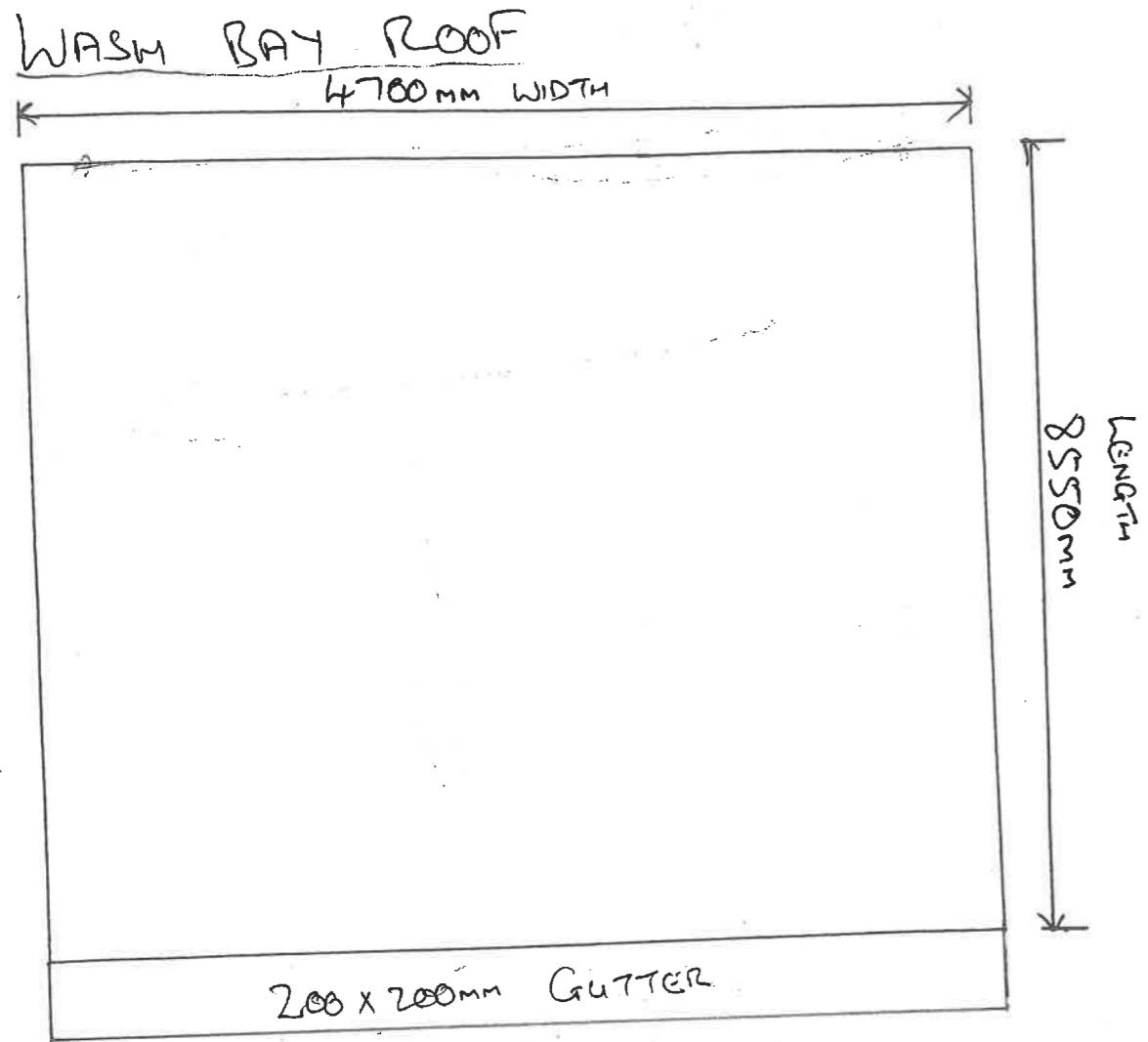

**PART A  
INVITATION TO BID**

<b>YOU ARE HEREBY INVITED TO BID FOR REQUIREMENTS OF THE FRANCES BAARD DISTRICT MUNICIPALITY</b>					
BID NUMBER:	BID 19/24	CLOSING DATE:	06 DECEMBER 2024	CLOSING TIME:	12H00
DESCRIPTION	<b>DEMOLISHING OF EXISTING CARPORTS AND REBUILD AT THE JAN KEMPDORP FIRE STATION</b>				
<b>THE SUCCESSFUL BIDDER WILL BE REQUIRED TO FILL IN AND SIGN A WRITTEN CONTRACT FORM (MBD7).</b>					

BID RESPONSE DOCUMENTS MAY BE DEPOSITED IN THE BID BOX  
SITUATED AT (STREET ADDRESS

<b>Frances Baard District Offices (Tender Box)</b>					
<b>51 Drakensberg Avenue</b>					
<b>Carters Glen</b>					
<b>Kimberley</b>					
<b>8301</b>					
<b>SUPPLIER INFORMATION</b>					
NAME OF BIDDER					
POSTAL ADDRESS					
STREET ADDRESS					
TELEPHONE NUMBER	CODE		NUMBER		
CELLPHONE NUMBER					
FACSIMILE NUMBER	CODE		NUMBER		
E-MAIL ADDRESS					
VAT REGISTRATION NUMBER					
TAX COMPLIANCE STATUS	TCS PIN:		OR	CSD No:	
ARE YOU THE ACCREDITED REPRESENTATIVE IN SOUTH AFRICA FOR THE GOODS /SERVICES OFFERED?	<input type="checkbox"/> Yes <input type="checkbox"/> No [IF YES ENCLOSE PROOF]	ARE YOU A FOREIGN BASED SUPPLIER FOR THE GOODS /SERVICES OFFERED?		<input type="checkbox"/> Yes <input type="checkbox"/> No [IF YES, ANSWER PART B:3 ]	
<b>TOTAL NUMBER OF ITEMS OFFERED</b>		<b>TOTAL BID PRICE</b>		<b>R</b>	
<b>SIGNATURE OF BIDDER</b>	.....	<b>DATE</b>			
<b>CAPACITY UNDER WHICH THIS BID IS SIGNED</b>					
<b>BIDDING PROCEDURE ENQUIRIES MAY BE DIRECTED TO:</b>			<b>TECHNICAL INFORMATION MAY BE DIRECTED TO:</b>		
DEPARTMENT	FINANCE - SCM	CONTACT PERSON	Mr. C. Jones		
CONTACT PERSON	Mr. Eric Tlhageng	TELEPHONE NUMBER	053 838 0925		
TELEPHONE NUMBER	053 838 0946	FACSIMILE NUMBER	053 861 1538		
FACSIMILE NUMBER	053 861 1538	E-MAIL ADDRESS	cliffie.jones@fbdm.co.za		
E-MAIL ADDRESS	eric.tlhageng@fbdm.co.za				

**PART B  
TERMS AND CONDITIONS FOR BIDDING**

<b>1. BID SUBMISSION:</b>	
1.1.	BIDS MUST BE DELIVERED BY THE STIPULATED TIME TO THE CORRECT ADDRESS. LATE BIDS WILL NOT BE ACCEPTED FOR CONSIDERATION.
1.2.	<b>ALL BIDS MUST BE SUBMITTED ON THE OFFICIAL FORMS PROVIDED (NOT TO BE RE-TYPED) OR ONLINE</b>
1.3.	THIS BID IS SUBJECT TO THE PREFERENTIAL PROCUREMENT POLICY FRAMEWORK ACT AND THE PREFERENTIAL PROCUREMENT REGULATIONS THE GENERAL CONDITIONS OF CONTRACT (GCC) AND, IF APPLICABLE, ANY OTHER SPECIAL CONDITIONS OF CONTRACT.
<b>2. TAX COMPLIANCE REQUIREMENTS</b>	
2.1	BIDDERS MUST ENSURE COMPLIANCE WITH THEIR TAX OBLIGATIONS.
2.2	BIDDERS ARE REQUIRED TO SUBMIT THEIR UNIQUE PERSONAL IDENTIFICATION NUMBER (PIN) ISSUED BY SARS TO ENABLE THE ORGAN OF STATE TO VIEW THE TAXPAYER'S PROFILE AND TAX STATUS.
2.3	APPLICATION FOR THE TAX COMPLIANCE STATUS (TCS) CERTIFICATE OR PIN MAY ALSO BE MADE VIA E-FILING. IN ORDER TO USE THIS PROVISION, TAXPAYERS WILL NEED TO REGISTER WITH SARS AS E-FILERS THROUGH THE WEBSITE WWW.SARS.GOV.ZA.
2.4	FOREIGN SUPPLIERS MUST COMPLETE THE PRE-AWARD QUESTIONNAIRE IN PART B:3.
2.5	BIDDERS MAY ALSO SUBMIT A PRINTED TCS CERTIFICATE TOGETHER WITH THE BID.
2.6	IN BIDS WHERE CONSORTIA / JOINT VENTURES / SUB-CONTRACTORS ARE INVOLVED, EACH PARTY MUST SUBMIT A SEPARATE TCS CERTIFICATE / PIN / CSD NUMBER.
2.7	WHERE NO TCS IS AVAILABLE BUT THE BIDDER IS REGISTERED ON THE CENTRAL SUPPLIER DATABASE (CSD), A CSD NUMBER MUST BE PROVIDED.
<b>3. QUESTIONNAIRE TO BIDDING FOREIGN SUPPLIERS</b>	
3.1.	IS THE ENTITY A RESIDENT OF THE REPUBLIC OF SOUTH AFRICA (RSA)? <span style="float:right"><input type="checkbox"/> YES <input type="checkbox"/> NO</span>
3.2.	DOES THE ENTITY HAVE A BRANCH IN THE RSA? <span style="float:right"><input type="checkbox"/> YES <input type="checkbox"/> NO</span>
3.3.	DOES THE ENTITY HAVE A PERMANENT ESTABLISHMENT IN THE RSA? <span style="float:right"><input type="checkbox"/> YES <input type="checkbox"/> NO</span>
3.4.	DOES THE ENTITY HAVE ANY SOURCE OF INCOME IN THE RSA? <span style="float:right"><input type="checkbox"/> YES <input type="checkbox"/> NO</span>
3.5.	IS THE ENTITY LIABLE IN THE RSA FOR ANY FORM OF TAXATION? <span style="float:right"><input type="checkbox"/> YES <input type="checkbox"/> NO</span>
<b>IF THE ANSWER IS "NO" TO ALL OF THE ABOVE, THEN IT IS NOT A REQUIREMENT TO REGISTER FOR A TAX COMPLIANCE STATUS SYSTEM PIN CODE FROM THE SOUTH AFRICAN REVENUE SERVICE (SARS) AND IF NOT REGISTER AS PER 2.3 ABOVE.</b>	

**NB: FAILURE TO PROVIDE ANY OF THE ABOVE PARTICULARS MAY RENDER THE BID INVALID.  
NO BIDS WILL BE CONSIDERED FROM PERSONS IN THE SERVICE OF THE STATE.**

SIGNATURE OF BIDDER: .....

CAPACITY UNDER WHICH THIS BID IS SIGNED: .....

DATE: .....

**PRICING SCHEDULE – FIRM PRICES**

**NOTE: ONLY FIRM PRICES WILL BE ACCEPTED. NON-FIRM PRICES (INCLUDING PRICES SUBJECT TO RATES OF EXCHANGE VARIATIONS) WILL NOT BE CONSIDERED**

Name of bidder .....	BID: 19/24
Closing Date and Time: 06 DECEMBER 2024 (12:00)	

OFFER TO BE VALID FOR (90) DAYS FROM THE CLOSING DATE OF BID.

**Pricing schedule**

<b>Description</b>	<b>Cost</b>
<b>Cost to demolish existing structure at FBDM including the usage of scaffolding.</b>	R.....
<b>Transportation cost of demolished structure to Jan Kempdorp fire station.</b>	R.....
<b>Cost to erect new structures at Jan Kempdorp including the usage of scaffolding.</b>	R.....
<b>Total excluding 15% Vat</b>	R.....
<b>15% Vat</b>	R.....
<b>Total including 15% Vat</b>	R.....

**Note:**

- Does the offer comply with the specification(s)? \*YES/NO
- If not to specification, indicate deviation(s) .....
- Period required for delivery .....  
\*Delivery: Firm/Not firm
- Delivery basis .....

Note: All delivery costs must be included in the bid price, for delivery at the prescribed destination.

\*\* "all applicable taxes" includes value- added tax, pay as you earn, income tax, unemployment insurance fund contributions and skills development levies.

\*Delete if not applicable contributions and skills development levies.



## DECLARATION OF INTEREST

1. No bid will be accepted from persons in the service of the state\*.
2. Any person, having a kinship with persons in the service of the state, including a blood relationship, may make an offer or offers in terms of this invitation to bid. In view of possible allegations of favouritism, should the resulting bid, or part thereof, be awarded to persons connected with or related to persons in service of the state, it is required that the bidder or their authorised representative declare their position in relation to the evaluating/adjudicating authority and/or take an oath declaring his/her interest.

**3 In order to give effect to the above, the following questionnaire must be completed and submitted with the bid.**

3.1 Full Name: .....

3.2 Identity Number: .....

3.3 Company Registration Number: .....

3.4 Tax Reference Number: .....

3.5 VAT Registration Number: .....

3.6 Are you presently in the service of the state\* **YES / NO**

3.6.1 If so, furnish particulars.

.....  
.....

3.7 Have you been in the service of the state for the past twelve months? **YES / NO**

3.7.1 If so, furnish particulars.

.....  
.....

---

\* MSCM Regulations: "in the service of the state" means to be –

- (a) a member of –
  - (i) any municipal council;
  - (ii) any provincial legislature; or
  - (iii) the national Assembly or the national Council of provinces;
- (b) a member of the board of directors of any municipal entity;
- (c) an official of any municipality or municipal entity;
- (d) an employee of any national or provincial department, national or provincial public entity or constitutional institution within the meaning of the Public Finance Management Act, 1999 (Act No.1 of 1999);
- (e) a member of the accounting authority of any national or provincial public entity; or
- (f) an employee of Parliament or a provincial legislature.

3.8 Do you, have any relationship (family, friend, other) with persons in the service of the state and who may be involved with the evaluation and or adjudication of this bid? **YES / NO**

3.8.1 If so, furnish particulars.

.....  
.....

3.9 Are you, aware of any relationship (family, friend, other) between a bidder and any persons in the service of the state who may be involved with the evaluation and or adjudication of this bid? **YES / NO**

3.9.1 If so, furnish particulars

.....  
.....

3.10 Are any of the company's directors, managers, principal shareholders or stakeholders in service of the state? **YES / NO**

3.10.1 If so, furnish particulars.

.....  
.....

3.11 Are any spouse, child or parent of the company's directors, managers, principal shareholders or stakeholders in service of the state? **YES / NO**

3.11.1 If so, furnish particulars.

.....  
.....

**CERTIFICATION**

**I, THE UNDERSIGNED (NAME) .....**

**CERTIFY THAT THE INFORMATION FURNISHED ON THIS DECLARATION FORM IS CORRECT.**

**I ACCEPT THAT THE STATE MAY ACT AGAINST ME SHOULD THIS DECLARATION PROVE TO BE FALSE. (A FALSE DECLARATION MAY RESULT IN CANCELLATION OF CONTRACT AND BLACK LISTING)**

.....  
Signature

.....  
Date

.....  
Position

.....  
Name of Bidder

**PREFERENCE POINTS CLAIM FORM IN TERMS OF THE PREFERENTIAL  
PROCUREMENT REGULATIONS 2022**

This preference form must form part of all tenders invited. It contains general information and serves as a claim form for preference points for specific goals.

**NB: BEFORE COMPLETING THIS FORM, TENDERERS MUST STUDY THE GENERAL CONDITIONS, DEFINITIONS AND DIRECTIVES APPLICABLE IN RESPECT OF THE TENDER AND PREFERENTIAL PROCUREMENT REGULATIONS, 2022**

**1. GENERAL CONDITIONS**

1.1 The following preference point systems are applicable to invitations to tender:

- the 80/20 system for requirements with a Rand value of up to R50 000 000 (all applicable taxes included); and
- the 90/10 system for requirements with a Rand value above R50 000 000 (all applicable taxes included).

1.2 **To be completed by the organ of state**

*(delete whichever is not applicable for this tender).*

- a) The applicable preference point system for this tender is the **90/10** preference point system.
- b) The applicable preference point system for this tender is the **80/20** preference point system.
- c) Either the **90/10 or 80/20 preference point system** will be applicable in this tender. The lowest/ highest acceptable tender will be used to determine the accurate system once tenders are received.

1.3 Points for this tender (even in the case of a tender for income-generating contracts) shall be awarded for:

- (a) Price; and
- (b) Specific Goals.

1.4 **To be completed by the organ of state:**

The maximum points for this tender are allocated as follows:

	POINTS
<b>PRICE</b>	<b>80</b>
<b>SPECIFIC GOALS</b>	<b>20</b>
<b>Total points for Price and SPECIFIC GOALS</b>	<b>100</b>

- 1.5 Failure on the part of a tenderer to submit proof or documentation required in terms of this tender to claim points for specific goals with the tender, will be interpreted to mean that preference points for specific goals are not claimed.
- 1.6 The organ of state reserves the right to require of a tenderer, either before a tender is adjudicated or at any time subsequently, to substantiate any claim in regard to preferences, in any manner required by the organ of state.

## 2. DEFINITIONS

- (a) “**tender**” means a written offer in the form determined by an organ of state in response to an invitation to provide goods or services through price quotations, competitive tendering process or any other method envisaged in legislation;
- (b) “**price**” means an amount of money tendered for goods or services, and includes all applicable taxes less all unconditional discounts;
- (c) “**rand value**” means the total estimated value of a contract in Rand, calculated at the time of bid invitation, and includes all applicable taxes;
- (d) “**tender for income-generating contracts**” means a written offer in the form determined by an organ of state in response to an invitation for the origination of income-generating contracts through any method envisaged in legislation that will result in a legal agreement between the organ of state and a third party that produces revenue for the organ of state, and includes, but is not limited to, leasing and disposal of assets and concession contracts, excluding direct sales and disposal of assets through public auctions; and
- (e) “**the Act**” means the Preferential Procurement Policy Framework Act, 2000 (Act No. 5 of 2000).

## 3. FORMULAE FOR PROCUREMENT OF GOODS AND SERVICES

### 3.1. POINTS AWARDED FOR PRICE

#### 3.1.1 THE 80/20 OR 90/10 PREFERENCE POINT SYSTEMS

A maximum of 80 or 90 points is allocated for price on the following basis:

$$\begin{array}{ccc}
 \mathbf{80/20} & \mathbf{or} & \mathbf{90/10} \\
 \\
 \mathbf{P_s = 80 \left( 1 - \frac{P_t - P_{min}}{P_{min}} \right)} & \mathbf{or} & \mathbf{P_s = 90 \left( 1 - \frac{P_t - P_{min}}{P_{min}} \right)}
 \end{array}$$

Where

- P<sub>s</sub> = Points scored for price of tender under consideration  
P<sub>t</sub> = Price of tender under consideration  
P<sub>min</sub> = Price of lowest acceptable tender

### 3.2. FORMULAE FOR DISPOSAL OR LEASING OF STATE ASSETS AND INCOME GENERATING PROCUREMENT

#### 3.2.1. POINTS AWARDED FOR PRICE

A maximum of 80 or 90 points is allocated for price on the following basis:

$$Ps = 80 \left( 1 + \frac{Pt - Pmax}{Pmax} \right) \text{ or } Ps = 90 \left( 1 + \frac{Pt - Pmax}{Pmax} \right)$$

Where

- Ps = Points scored for price of tender under consideration  
Pt = Price of tender under consideration  
Pmax = Price of highest acceptable tender

### 4. POINTS AWARDED FOR SPECIFIC GOALS

- 4.1. In terms of Regulation 4(2); 5(2); 6(2) and 7(2) of the Preferential Procurement Regulations, preference points must be awarded for specific goals stated in the tender. For the purposes of this tender the tenderer will be allocated points based on the goals stated in table 1 below as may be supported by proof/ documentation stated in the conditions of this tender:
- 4.2. In cases where organs of state intend to use Regulation 3(2) of the Regulations, which states that, if it is unclear whether the 80/20 or 90/10 preference point system applies, an organ of state must, in the tender documents, stipulate in the case of—
- (a) an invitation for tender for income-generating contracts, that either the 80/20 or 90/10 preference point system will apply and that the highest acceptable tender will be used to determine the applicable preference point system; or
  - (b) any other invitation for tender, that either the 80/20 or 90/10 preference point system will apply and that the lowest acceptable tender will be used to determine the applicable preference point system,
- then the organ of state must indicate the points allocated for specific goals for both the 90/10 and 80/20 preference point system.

**Table 1: Specific goals for the tender and points claimed are indicated per the table below.**

***(Note to organs of state: Where either the 90/10 or 80/20 preference point system is applicable, corresponding points must also be indicated as such.)***

***Note to tenderers: The tenderer must indicate how they claim points for each preference point system.)***

The specific goals allocated points in terms of this tender	Number of points allocated (90/10 system) (To be completed by the organ of state)	Number of points allocated (80/20 system) (To be completed by the organ of state)	Number of points claimed (90/10 system) (To be completed by the tenderer)	Number of points claimed (80/20 system) (To be completed by the tenderer)
Enterprises located in the district municipal area		20		

The objectives as specific goals in line with section 2(1) of the Act, is to:

- Promote local labour and/ or promotion of enterprises located in the district municipal area of which 20 points is allocated,
- Enterprises within Northern Cape outside the district municipal area 10 points and
- Enterprises outside Northern Cape 5 points.

**DECLARATION WITH REGARD TO COMPANY/FIRM**

4.3. Name of company/firm.....

4.4. Company registration number: .....

4.5. TYPE OF COMPANY/ FIRM

- Partnership/Joint Venture / Consortium
- One-person business/sole propriety
- Close corporation
- Public Company
- Personal Liability Company
- (Pty) Limited
- Non-Profit Company
- State Owned Company

[TICK APPLICABLE BOX]

4.6. I, the undersigned, who is duly authorised to do so on behalf of the company/firm, certify that the points claimed, based on the specific goals as advised in the tender, qualifies the company/ firm for the preference(s) shown and I acknowledge that:

- i) The information furnished is true and correct;
- ii) The preference points claimed are in accordance with the General Conditions as indicated in paragraph 1 of this form;
- iii) In the event of a contract being awarded as a result of points claimed as shown in paragraphs 1.4 and 4.2, the contractor may be required to furnish documentary proof to the satisfaction of the organ of state that the claims are correct;
- iv) If the specific goals have been claimed or obtained on a fraudulent basis or any of the conditions of contract have not been fulfilled, the organ of state may, in addition to any other remedy it may have –
  - (a) disqualify the person from the tendering process;
  - (b) recover costs, losses or damages it has incurred or suffered as a result of that person's conduct;
  - (c) cancel the contract and claim any damages which it has suffered as a result of having to make less favourable arrangements due to such cancellation;
  - (d) recommend that the tenderer or contractor, its shareholders and directors, or only the shareholders and directors who acted on a fraudulent basis, be restricted from obtaining business from any organ of state for a period not exceeding 10 years, after the *audi alteram partem* (hear the other side) rule has been applied; and
  - (e) forward the matter for criminal prosecution, if deemed necessary.

.....	
<b>SIGNATURE(S) OF TENDERER(S)</b>	
<b>SURNAME AND NAME:</b>	.....
<b>DATE:</b>	.....
<b>ADDRESS:</b>	.....
	.....
	.....
	.....



**CONTRACT FORM - RENDERING OF SERVICES**

**THIS FORM MUST BE FILLED IN DUPLICATE BY BOTH THE SERVICE PROVIDER (PART 1) AND THE PURCHASER (PART 2). BOTH FORMS MUST BE SIGNED IN THE ORIGINAL SO THAT THE SERVICE PROVIDER AND THE PURCHASER WOULD BE IN POSSESSION OF ORIGINALLY SIGNED CONTRACTS FOR THEIR RESPECTIVE RECORDS.**

**PART 1 (TO BE FILLED IN BY THE SERVICE PROVIDER)**

1. I hereby undertake to render services described in the attached bidding documents to (name of the institution)..... in accordance with the requirements and task directives / proposals specifications stipulated in Bid Number..... at the price/s quoted. My offer/s remain binding upon me and open for acceptance by the Purchaser during the validity period indicated and calculated from the closing date of the bid.
  
2. The following documents shall be deemed to form and be read and construed as part of this agreement:
  - (i) Bidding documents, viz
    - Invitation to bid;
    - Proof of tax compliance status;
    - Pricing schedule(s);
    - Filled in task directive/proposal;
    - Preference claim form for Preferential Procurement in terms of the Preferential Procurement Regulations;
    - Declaration of interest;
    - Declaration of Bidder's past SCM practices;
    - Certificate of Independent Bid Determination;
    - Special Conditions of Contract;
  - (ii) General Conditions of Contract; and
  - (iii) Other (specify)
  
3. I confirm that I have satisfied myself as to the correctness and validity of my bid; that the price(s) and rate(s) quoted cover all the services specified in the bidding documents; that the price(s) and rate(s) cover all my obligations and I accept that any mistakes regarding price(s) and rate(s) and calculations will be at my own risk.
  
4. I accept full responsibility for the proper execution and fulfilment of all obligations and conditions devolving on me under this agreement as the principal liable for the due fulfillment of this contract.
  
5. I declare that I have no participation in any collusive practices with any bidder or any other person regarding this or any other bid.
  
6. I confirm that I am duly authorised to sign this contract.

NAME (PRINT) .....

CAPACITY .....

SIGNATURE .....

NAME OF FIRM .....

DATE .....

<b>WITNESSES</b>	
1	.....
2	.....
DATE:	.....

**CONTRACT FORM - RENDERING OF SERVICES**

**PART 2 (TO BE FILLED IN BY THE PURCHASER)**

1. I..... in my capacity as..... accept your bid under reference number .....dated.....for the rendering of services indicated hereunder and/or further specified in the annexure(s).
2. An official order indicating service delivery instructions is forthcoming.
3. I undertake to make payment for the services rendered in accordance with the terms and conditions of the contract, within 30 (thirty) days after receipt of an invoice.

DESCRIPTION OF SERVICE	PRICE (ALL APPLICABLE TAXES INCLUDED)	COMPLETION DATE	TOTAL PREFERENCE POINTS CLAIMED	POINTS CLAIMED FOR EACH SPECIFIC GOAL

4. I confirm that I am duly authorised to sign this contract.

SIGNED AT ..... ON .....

NAME (PRINT) .....

SIGNATURE .....

OFFICIAL STAMP

WITNESSES

1 .....

2 .....

DATE: .....

## DECLARATION OF BIDDER'S PAST SUPPLY CHAIN MANAGEMENT PRACTICES

- 1 This Municipal Bidding Document must form part of all bids invited.
- 2 It serves as a declaration to be used by municipalities and municipal entities in ensuring that when goods and services are being procured, all reasonable steps are taken to combat the abuse of the supply chain management system.
- 3 The bid of any bidder may be rejected if that bidder, or any of its directors have:
  - a. abused the municipality's / municipal entity's supply chain management system or committed any improper conduct in relation to such system;
  - b. been convicted for fraud or corruption during the past five years;
  - c. willfully neglected, reneged on or failed to comply with any government, municipal or other public sector contract during the past five years; or
  - d. been listed in the Register for Tender Defaulters in terms of section 29 of the Prevention and Combating of Corrupt Activities Act (No 12 of 2004).
- 4 **In order to give effect to the above, the following questionnaire must be completed and submitted with the bid.**

Item	Question	Yes	No
4.1	<p>Is the bidder or any of its directors listed on the National Treasury's Database of Restricted Suppliers as companies or persons prohibited from doing business with the public sector?</p> <p>(Companies or persons who are listed on this Database were informed in writing of this restriction by the Accounting Officer/Authority of the institution that imposed the restriction after the <i>audi alteram partem</i> rule was applied).</p> <p><b>The Database of Restricted Suppliers now resides on the National Treasury's website(<a href="http://www.treasury.gov.za">www.treasury.gov.za</a>) and can be accessed by clicking on its link at the bottom of the home page.</b></p>	Yes <input type="checkbox"/>	No <input type="checkbox"/>
4.1.1	If so, furnish particulars:		
4.2	<p>Is the bidder or any of its directors listed on the Register for Tender Defaulters in terms of section 29 of the Prevention and Combating of Corrupt Activities Act (No 12 of 2004)?</p> <p><b>The Register for Tender Defaulters can be accessed on the National Treasury's website (<a href="http://www.treasury.gov.za">www.treasury.gov.za</a>) by clicking on its link at the bottom of the home page.</b></p>	Yes <input type="checkbox"/>	No <input type="checkbox"/>
4.2.1	If so, furnish particulars:		
4.3	<p>Was the bidder or any of its directors convicted by a court of law (including a court of law outside the Republic of South Africa) for fraud or corruption during the past five years?</p>	Yes <input type="checkbox"/>	No <input type="checkbox"/>

4.3.1	If so, furnish particulars:		
<b>Item</b>	<b>Question</b>	<b>Yes</b>	<b>No</b>
4.4	Does the bidder or any of its directors owe any municipal rates and taxes or municipal charges to the municipality / municipal entity, or to any other municipality / municipal entity, that is in arrears for more than three months?	Yes <input type="checkbox"/>	No <input type="checkbox"/>
4.4.1	If so, furnish particulars:		
4.5	Was any contract between the bidder and the municipality / municipal entity or any other organ of state terminated during the past five years on account of failure to perform on or comply with the contract?	Yes <input type="checkbox"/>	No <input type="checkbox"/>
4.7.1	If so, furnish particulars:		

**CERTIFICATION**

**I, THE UNDERSIGNED (FULL NAME) .....  
CERTIFY THAT THE INFORMATION FURNISHED ON THIS  
DECLARATION FORM TRUE AND CORRECT.**

**I ACCEPT THAT, IN ADDITION TO CANCELLATION OF A CONTRACT,  
ACTION MAY BE TAKEN AGAINST ME SHOULD THIS DECLARATION  
PROVE TO BE FALSE.**

.....  
**Signature**

.....  
**Date**

.....  
**Position**

.....  
**Name of Bidder**

**CERTIFICATE OF INDEPENDENT BID DETERMINATION**

- 1 This Municipal Bidding Document (MBD) must form part of all bids<sup>1</sup> invited.
  
- 2 Section 4 (1) (b) (iii) of the Competition Act No. 89 of 1998, as amended, prohibits an agreement between, or concerted practice by, firms, or a decision by an association of firms, if it is between parties in a horizontal relationship and if it involves collusive bidding (or bid rigging).<sup>2</sup> Collusive bidding is a *pe se* prohibition meaning that it cannot be justified under any grounds.
  
- 3 Municipal Supply Regulation 38 (1) prescribes that a supply chain management policy must provide measures for the combating of abuse of the supply chain management system, and must enable the accounting officer, among others, to:
  - a. take all reasonable steps to prevent such abuse;
  - b. reject the bid of any bidder if that bidder or any of its directors has abused the supply chain management system of the municipality or municipal entity or has committed any improper conduct in relation to such system; and
  - c. cancel a contract awarded to a person if the person committed any corrupt or fraudulent act during the bidding process or the execution of the contract.
  
- 4 This MBD serves as a certificate of declaration that would be used by institutions to ensure that, when bids are considered, reasonable steps are taken to prevent any form of bid-rigging.
  
- 5 In order to give effect to the above, the attached Certificate of Bid Determination (MBD 9) must be completed and submitted with the bid:

<sup>1</sup> Includes price quotations, advertised competitive bids, limited bids and proposals.

<sup>2</sup> Bid rigging (or collusive bidding) occurs when businesses, that would otherwise be expected to compete, secretly conspire to raise prices or lower the quality of goods and / or services for purchasers who wish to acquire goods and / or services through a bidding process. Bid rigging is, therefore, an agreement between competitors not to compete.

**CERTIFICATE OF INDEPENDENT BID DETERMINATION**

I, the undersigned, in submitting the accompanying bid:

---

(Bid Number and Description)

in response to the invitation for the bid made by:

---

(Name of Municipality / Municipal Entity)

do hereby make the following statements that I certify to be true and complete in every respect:

I certify, on behalf of: \_\_\_\_\_ that:

(Name of Bidder)

1. I have read and I understand the contents of this Certificate;
2. I understand that the accompanying bid will be disqualified if this Certificate is found not to be true and complete in every respect;
3. I am authorized by the bidder to sign this Certificate, and to submit the accompanying bid, on behalf of the bidder;
4. Each person whose signature appears on the accompanying bid has been authorized by the bidder to determine the terms of, and to sign, the bid, on behalf of the bidder;
5. For the purposes of this Certificate and the accompanying bid, I understand that the word "competitor" shall include any individual or organization, other than the bidder, whether or not affiliated with the bidder, who:
  - (a) has been requested to submit a bid in response to this bid invitation;
  - (b) could potentially submit a bid in response to this bid invitation, based on their qualifications, abilities or experience; and
  - (c) provides the same goods and services as the bidder and/or is in the same line of business as the bidder

6. The bidder has arrived at the accompanying bid independently from, and without consultation, communication, agreement or arrangement with any competitor. However communication between partners in a joint venture or consortium<sup>3</sup> will not be construed as collusive bidding.
7. In particular, without limiting the generality of paragraphs 6 above, there has been no consultation, communication, agreement or arrangement with any competitor regarding:
  - (a) prices;
  - (b) geographical area where product or service will be rendered (market allocation)
  - (c) methods, factors or formulas used to calculate prices;
  - (d) the intention or decision to submit or not to submit, a bid;
  - (e) the submission of a bid which does not meet the specifications and conditions of the bid; or
  - (f) bidding with the intention not to win the bid.
8. In addition, there have been no consultations, communications, agreements or arrangements with any competitor regarding the quality, quantity, specifications and conditions or delivery particulars of the products or services to which this bid invitation relates.
9. The terms of the accompanying bid have not been, and will not be, disclosed by the bidder, directly or indirectly, to any competitor, prior to the date and time of the official bid opening or of the awarding of the contract.

<sup>3</sup> Joint venture or Consortium means an association of persons for the purpose of combining their expertise, property, capital, efforts, skill and knowledge in an activity for the execution of a contract.

10. I am aware that, in addition and without prejudice to any other remedy provided to combat any restrictive practices related to bids and contracts, bids that are suspicious will be reported to the Competition Commission for investigation and possible imposition of administrative penalties in terms of section 59 of the Competition Act No 89 of 1998 and or may be reported to the National Prosecuting Authority (NPA) for criminal investigation and or may be restricted from conducting business with the public sector for a period not exceeding ten (10) years in terms of the Prevention and Combating of Corrupt Activities Act No 12 of 2004 or any other applicable legislation.

.....	.....
Signature	Date
.....	.....
Position	Name of Bidder

Js9141w 4



# **THE NATIONAL TREASURY**

**Republic of South Africa**



---

## **GOVERNMENT PROCUREMENT: GENERAL CONDITIONS OF CONTRACT**

**July 2010**

**GOVERNMENT PROCUREMENT**  
**GENERAL CONDITIONS OF CONTRACT**  
**July 2010**

**NOTES**

The purpose of this document is to:

- (i) Draw special attention to certain general conditions applicable to government bids, contracts and orders; and
- (ii) To ensure that clients be familiar with regard to the rights and obligations of all parties involved in doing business with government.

In this document words in the singular also mean in the plural and vice versa and words in the masculine also mean in the feminine and neuter.

- The General Conditions of Contract will form part of all bid documents and may not be amended.
- Special Conditions of Contract (SCC) relevant to a specific bid, should be compiled separately for every bid (if applicable) and will supplement the General Conditions of Contract. Whenever there is a conflict, the provisions in the SCC shall prevail.

## TABLE OF CLAUSES

1. Definitions
2. Application
3. General
4. Standards
5. Use of contract documents and information; inspection
6. Patent rights
7. Performance security
8. Inspections, tests and analysis
9. Packing
10. Delivery and documents
11. Insurance
12. Transportation
13. Incidental services
14. Spare parts
15. Warranty
16. Payment
17. Prices
18. Contract amendments
19. Assignment
20. Subcontracts
21. Delays in the supplier's performance
22. Penalties
23. Termination for default
24. Dumping and countervailing duties
25. Force Majeure
26. Termination for insolvency
27. Settlement of disputes
28. Limitation of liability
29. Governing language
30. Applicable law
31. Notices
32. Taxes and duties
33. National Industrial Participation Programme (NIPP)
34. Prohibition of restrictive practices

## General Conditions of Contract

### 1. Definitions

1. The following terms shall be interpreted as indicated:
  - 1.1 “Closing time” means the date and hour specified in the bidding documents for the receipt of bids.
  - 1.2 “Contract” means the written agreement entered into between the purchaser and the supplier, as recorded in the contract form signed by the parties, including all attachments and appendices thereto and all documents incorporated by reference therein.
  - 1.3 “Contract price” means the price payable to the supplier under the contract for the full and proper performance of his contractual obligations.
  - 1.4 “Corrupt practice” means the offering, giving, receiving, or soliciting of any thing of value to influence the action of a public official in the procurement process or in contract execution.
  - 1.5 "Countervailing duties" are imposed in cases where an enterprise abroad is subsidized by its government and encouraged to market its products internationally.
  - 1.6 “Country of origin” means the place where the goods were mined, grown or produced or from which the services are supplied. Goods are produced when, through manufacturing, processing or substantial and major assembly of components, a commercially recognized new product results that is substantially different in basic characteristics or in purpose or utility from its components.
  - 1.7 “Day” means calendar day.
  - 1.8 “Delivery” means delivery in compliance of the conditions of the contract or order.
  - 1.9 “Delivery ex stock” means immediate delivery directly from stock actually on hand.
  - 1.10 “Delivery into consignees store or to his site” means delivered and unloaded in the specified store or depot or on the specified site in compliance with the conditions of the contract or order, the supplier bearing all risks and charges involved until the supplies are so delivered and a valid receipt is obtained.
  - 1.11 "Dumping" occurs when a private enterprise abroad market its goods on own initiative in the RSA at lower prices than that of the country of origin and which have the potential to harm the local industries in the

RSA.

- 1.12 "Force majeure" means an event beyond the control of the supplier and not involving the supplier's fault or negligence and not foreseeable. Such events may include, but is not restricted to, acts of the purchaser in its sovereign capacity, wars or revolutions, fires, floods, epidemics, quarantine restrictions and freight embargoes.
- 1.13 "Fraudulent practice" means a misrepresentation of facts in order to influence a procurement process or the execution of a contract to the detriment of any bidder, and includes collusive practice among bidders (prior to or after bid submission) designed to establish bid prices at artificial non-competitive levels and to deprive the bidder of the benefits of free and open competition.
- 1.14 "GCC" means the General Conditions of Contract.
- 1.15 "Goods" means all of the equipment, machinery, and/or other materials that the supplier is required to supply to the purchaser under the contract.
- 1.16 "Imported content" means that portion of the bidding price represented by the cost of components, parts or materials which have been or are still to be imported (whether by the supplier or his subcontractors) and which costs are inclusive of the costs abroad, plus freight and other direct importation costs such as landing costs, dock dues, import duty, sales duty or other similar tax or duty at the South African place of entry as well as transportation and handling charges to the factory in the Republic where the supplies covered by the bid will be manufactured.
- 1.17 "Local content" means that portion of the bidding price which is not included in the imported content provided that local manufacture does take place.
- 1.18 "Manufacture" means the production of products in a factory using labour, materials, components and machinery and includes other related value-adding activities.
- 1.19 "Order" means an official written order issued for the supply of goods or works or the rendering of a service.
- 1.20 "Project site," where applicable, means the place indicated in bidding documents.
- 1.21 "Purchaser" means the organization purchasing the goods.
- 1.22 "Republic" means the Republic of South Africa.
- 1.23 "SCC" means the Special Conditions of Contract.
- 1.24 "Services" means those functional services ancillary to the supply of the goods, such as transportation and any other incidental services, such as installation, commissioning, provision of technical assistance, training, catering, gardening, security, maintenance and other such

obligations of the supplier covered under the contract.

1.25 “Written” or “in writing” means handwritten in ink or any form of electronic or mechanical writing.

## **2. Application**

2.1 These general conditions are applicable to all bids, contracts and orders including bids for functional and professional services, sales, hiring, letting and the granting or acquiring of rights, but excluding immovable property, unless otherwise indicated in the bidding documents.

2.2 Where applicable, special conditions of contract are also laid down to cover specific supplies, services or works.

2.3 Where such special conditions of contract are in conflict with these general conditions, the special conditions shall apply.

## **3. General**

3.1 Unless otherwise indicated in the bidding documents, the purchaser shall not be liable for any expense incurred in the preparation and submission of a bid. Where applicable a non-refundable fee for documents may be charged.

3.2 With certain exceptions, invitations to bid are only published in the Government Tender Bulletin. The Government Tender Bulletin may be obtained directly from the Government Printer, Private Bag X85, Pretoria 0001, or accessed electronically from [www.treasury.gov.za](http://www.treasury.gov.za)

## **4. Standards**

4.1 The goods supplied shall conform to the standards mentioned in the bidding documents and specifications.

## **5. Use of contract documents and information; inspection.**

5.1 The supplier shall not, without the purchaser’s prior written consent, disclose the contract, or any provision thereof, or any specification, plan, drawing, pattern, sample, or information furnished by or on behalf of the purchaser in connection therewith, to any person other than a person employed by the supplier in the performance of the contract. Disclosure to any such employed person shall be made in confidence and shall extend only so far as may be necessary for purposes of such performance.

5.2 The supplier shall not, without the purchaser’s prior written consent, make use of any document or information mentioned in GCC clause 5.1 except for purposes of performing the contract.

5.3 Any document, other than the contract itself mentioned in GCC clause 5.1 shall remain the property of the purchaser and shall be returned (all copies) to the purchaser on completion of the supplier’s performance under the contract if so required by the purchaser.

5.4 The supplier shall permit the purchaser to inspect the supplier’s records relating to the performance of the supplier and to have them audited by auditors appointed by the purchaser, if so required by the purchaser.

## **6. Patent rights**

6.1 The supplier shall indemnify the purchaser against all third-party claims of infringement of patent, trademark, or industrial design rights arising from use of the goods or any part thereof by the purchaser.

**7. Performance security**

- 7.1 Within thirty (30) days of receipt of the notification of contract award, the successful bidder shall furnish to the purchaser the performance security of the amount specified in SCC.
- 7.2 The proceeds of the performance security shall be payable to the purchaser as compensation for any loss resulting from the supplier's failure to complete his obligations under the contract.
- 7.3 The performance security shall be denominated in the currency of the contract, or in a freely convertible currency acceptable to the purchaser and shall be in one of the following forms:
- (a) a bank guarantee or an irrevocable letter of credit issued by a reputable bank located in the purchaser's country or abroad, acceptable to the purchaser, in the form provided in the bidding documents or another form acceptable to the purchaser; or
  - (b) a cashier's or certified cheque
- 7.4 The performance security will be discharged by the purchaser and returned to the supplier not later than thirty (30) days following the date of completion of the supplier's performance obligations under the contract, including any warranty obligations, unless otherwise specified in SCC.

**8. Inspections, tests and analyses**

- 8.1 All pre-bidding testing will be for the account of the bidder.
- 8.2 If it is a bid condition that supplies to be produced or services to be rendered should at any stage during production or execution or on completion be subject to inspection, the premises of the bidder or contractor shall be open, at all reasonable hours, for inspection by a representative of the Department or an organization acting on behalf of the Department.
- 8.3 If there are no inspection requirements indicated in the bidding documents and no mention is made in the contract, but during the contract period it is decided that inspections shall be carried out, the purchaser shall itself make the necessary arrangements, including payment arrangements with the testing authority concerned.
- 8.4 If the inspections, tests and analyses referred to in clauses 8.2 and 8.3 show the supplies to be in accordance with the contract requirements, the cost of the inspections, tests and analyses shall be defrayed by the purchaser.
- 8.5 Where the supplies or services referred to in clauses 8.2 and 8.3 do not comply with the contract requirements, irrespective of whether such supplies or services are accepted or not, the cost in connection with these inspections, tests or analyses shall be defrayed by the supplier.
- 8.6 Supplies and services which are referred to in clauses 8.2 and 8.3 and which do not comply with the contract requirements may be rejected.
- 8.7 Any contract supplies may on or after delivery be inspected, tested or

analyzed and may be rejected if found not to comply with the requirements of the contract. Such rejected supplies shall be held at the cost and risk of the supplier who shall, when called upon, remove them immediately at his own cost and forthwith substitute them with supplies which do comply with the requirements of the contract. Failing such removal the rejected supplies shall be returned at the suppliers cost and risk. Should the supplier fail to provide the substitute supplies forthwith, the purchaser may, without giving the supplier further opportunity to substitute the rejected supplies, purchase such supplies as may be necessary at the expense of the supplier.

8.8 The provisions of clauses 8.4 to 8.7 shall not prejudice the right of the purchaser to cancel the contract on account of a breach of the conditions thereof, or to act in terms of Clause 23 of GCC.

**9. Packing**

9.1 The supplier shall provide such packing of the goods as is required to prevent their damage or deterioration during transit to their final destination, as indicated in the contract. The packing shall be sufficient to withstand, without limitation, rough handling during transit and exposure to extreme temperatures, salt and precipitation during transit, and open storage. Packing, case size and weights shall take into consideration, where appropriate, the remoteness of the goods' final destination and the absence of heavy handling facilities at all points in transit.

9.2 The packing, marking, and documentation within and outside the packages shall comply strictly with such special requirements as shall be expressly provided for in the contract, including additional requirements, if any, specified in SCC, and in any subsequent instructions ordered by the purchaser.

**10. Delivery and documents**

10.1 Delivery of the goods shall be made by the supplier in accordance with the terms specified in the contract. The details of shipping and/or other documents to be furnished by the supplier are specified in SCC.

10.2 Documents to be submitted by the supplier are specified in SCC.

**11. Insurance**

11.1 The goods supplied under the contract shall be fully insured in a freely convertible currency against loss or damage incidental to manufacture or acquisition, transportation, storage and delivery in the manner specified in the SCC.

**12. Transportation**

12.1 Should a price other than an all-inclusive delivered price be required, this shall be specified in the SCC.

**13. Incidental services**

13.1 The supplier may be required to provide any or all of the following services, including additional services, if any, specified in SCC:

- (a) performance or supervision of on-site assembly and/or commissioning of the supplied goods;
- (b) furnishing of tools required for assembly and/or maintenance of the supplied goods;
- (c) furnishing of a detailed operations and maintenance manual for each appropriate unit of the supplied goods;



- (d) performance or supervision or maintenance and/or repair of the supplied goods, for a period of time agreed by the parties, provided that this service shall not relieve the supplier of any warranty obligations under this contract; and
- (e) training of the purchaser's personnel, at the supplier's plant and/or on-site, in assembly, start-up, operation, maintenance, and/or repair of the supplied goods.

13.2 Prices charged by the supplier for incidental services, if not included in the contract price for the goods, shall be agreed upon in advance by the parties and shall not exceed the prevailing rates charged to other parties by the supplier for similar services.

#### **14. Spare parts**

14.1 As specified in SCC, the supplier may be required to provide any or all of the following materials, notifications, and information pertaining to spare parts manufactured or distributed by the supplier:

- (a) such spare parts as the purchaser may elect to purchase from the supplier, provided that this election shall not relieve the supplier of any warranty obligations under the contract; and
- (b) in the event of termination of production of the spare parts:
  - (i) Advance notification to the purchaser of the pending termination, in sufficient time to permit the purchaser to procure needed requirements; and
  - (ii) following such termination, furnishing at no cost to the purchaser, the blueprints, drawings, and specifications of the spare parts, if requested.

#### **15. Warranty**

15.1 The supplier warrants that the goods supplied under the contract are new, unused, of the most recent or current models, and that they incorporate all recent improvements in design and materials unless provided otherwise in the contract. The supplier further warrants that all goods supplied under this contract shall have no defect, arising from design, materials, or workmanship (except when the design and/or material is required by the purchaser's specifications) or from any act or omission of the supplier, that may develop under normal use of the supplied goods in the conditions prevailing in the country of final destination.

15.2 This warranty shall remain valid for twelve (12) months after the goods, or any portion thereof as the case may be, have been delivered to and accepted at the final destination indicated in the contract, or for eighteen (18) months after the date of shipment from the port or place of loading in the source country, whichever period concludes earlier, unless specified otherwise in SCC.

15.3 The purchaser shall promptly notify the supplier in writing of any claims arising under this warranty.

15.4 Upon receipt of such notice, the supplier shall, within the period specified in SCC and with all reasonable speed, repair or replace the defective goods or parts thereof, without costs to the purchaser.

15.5 If the supplier, having been notified, fails to remedy the defect(s) within the period specified in SCC, the purchaser may proceed to take

such remedial action as may be necessary, at the supplier's risk and expense and without prejudice to any other rights which the purchaser may have against the supplier under the contract.

- 16. Payment**
- 16.1 The method and conditions of payment to be made to the supplier under this contract shall be specified in SCC.
- 16.2 The supplier shall furnish the purchaser with an invoice accompanied by a copy of the delivery note and upon fulfillment of other obligations stipulated in the contract.
- 16.3 Payments shall be made promptly by the purchaser, but in no case later than thirty (30) days after submission of an invoice or claim by the supplier.
- 16.4 Payment will be made in Rand unless otherwise stipulated in SCC.
- 17. Prices**
- 17.1 Prices charged by the supplier for goods delivered and services performed under the contract shall not vary from the prices quoted by the supplier in his bid, with the exception of any price adjustments authorized in SCC or in the purchaser's request for bid validity extension, as the case may be.
- 18. Contract amendments**
- 18.1 No variation in or modification of the terms of the contract shall be made except by written amendment signed by the parties concerned.
- 19. Assignment**
- 19.1 The supplier shall not assign, in whole or in part, its obligations to perform under the contract, except with the purchaser's prior written consent.
- 20. Subcontracts**
- 20.1 The supplier shall notify the purchaser in writing of all subcontracts awarded under this contracts if not already specified in the bid. Such notification, in the original bid or later, shall not relieve the supplier from any liability or obligation under the contract.
- 21. Delays in the supplier's performance**
- 21.1 Delivery of the goods and performance of services shall be made by the supplier in accordance with the time schedule prescribed by the purchaser in the contract.
- 21.2 If at any time during performance of the contract, the supplier or its subcontractor(s) should encounter conditions impeding timely delivery of the goods and performance of services, the supplier shall promptly notify the purchaser in writing of the fact of the delay, its likely duration and its cause(s). As soon as practicable after receipt of the supplier's notice, the purchaser shall evaluate the situation and may at his discretion extend the supplier's time for performance, with or without the imposition of penalties, in which case the extension shall be ratified by the parties by amendment of contract.
- 21.3 No provision in a contract shall be deemed to prohibit the obtaining of supplies or services from a national department, provincial department, or a local authority.
- 21.4 The right is reserved to procure outside of the contract small quantities or to have minor essential services executed if an emergency arises, the

supplier's point of supply is not situated at or near the place where the supplies are required, or the supplier's services are not readily available.

21.5 Except as provided under GCC Clause 25, a delay by the supplier in the performance of its delivery obligations shall render the supplier liable to the imposition of penalties, pursuant to GCC Clause 22, unless an extension of time is agreed upon pursuant to GCC Clause 21.2 without the application of penalties.

21.6 Upon any delay beyond the delivery period in the case of a supplies contract, the purchaser shall, without canceling the contract, be entitled to purchase supplies of a similar quality and up to the same quantity in substitution of the goods not supplied in conformity with the contract and to return any goods delivered later at the supplier's expense and risk, or to cancel the contract and buy such goods as may be required to complete the contract and without prejudice to his other rights, be entitled to claim damages from the supplier.

## **22. Penalties**

22.1 Subject to GCC Clause 25, if the supplier fails to deliver any or all of the goods or to perform the services within the period(s) specified in the contract, the purchaser shall, without prejudice to its other remedies under the contract, deduct from the contract price, as a penalty, a sum calculated on the delivered price of the delayed goods or unperformed services using the current prime interest rate calculated for each day of the delay until actual delivery or performance. The purchaser may also consider termination of the contract pursuant to GCC Clause 23.

## **23. Termination for default**

23.1 The purchaser, without prejudice to any other remedy for breach of contract, by written notice of default sent to the supplier, may terminate this contract in whole or in part:

- (a) if the supplier fails to deliver any or all of the goods within the period(s) specified in the contract, or within any extension thereof granted by the purchaser pursuant to GCC Clause 21.2;
- (b) if the Supplier fails to perform any other obligation(s) under the contract; or
- (c) if the supplier, in the judgment of the purchaser, has engaged in corrupt or fraudulent practices in competing for or in executing the contract.

23.2 In the event the purchaser terminates the contract in whole or in part, the purchaser may procure, upon such terms and in such manner as it deems appropriate, goods, works or services similar to those undelivered, and the supplier shall be liable to the purchaser for any excess costs for such similar goods, works or services. However, the supplier shall continue performance of the contract to the extent not terminated.

23.3 Where the purchaser terminates the contract in whole or in part, the purchaser may decide to impose a restriction penalty on the supplier by prohibiting such supplier from doing business with the public sector for a period not exceeding 10 years.

23.4 If a purchaser intends imposing a restriction on a supplier or any

person associated with the supplier, the supplier will be allowed a time period of not more than fourteen (14) days to provide reasons why the envisaged restriction should not be imposed. Should the supplier fail to respond within the stipulated fourteen (14) days the purchaser may regard the intended penalty as not objected against and may impose it on the supplier.

23.5 Any restriction imposed on any person by the Accounting Officer / Authority will, at the discretion of the Accounting Officer / Authority, also be applicable to any other enterprise or any partner, manager, director or other person who wholly or partly exercises or exercised or may exercise control over the enterprise of the first-mentioned person, and with which enterprise or person the first-mentioned person, is or was in the opinion of the Accounting Officer / Authority actively associated.

23.6 If a restriction is imposed, the purchaser must, within five (5) working days of such imposition, furnish the National Treasury, with the following information:

- (i) the name and address of the supplier and / or person restricted by the purchaser;
- (ii) the date of commencement of the restriction
- (iii) the period of restriction; and
- (iv) the reasons for the restriction.

These details will be loaded in the National Treasury's central database of suppliers or persons prohibited from doing business with the public sector.

23.7 If a court of law convicts a person of an offence as contemplated in sections 12 or 13 of the Prevention and Combating of Corrupt Activities Act, No. 12 of 2004, the court may also rule that such person's name be endorsed on the Register for Tender Defaulters. When a person's name has been endorsed on the Register, the person will be prohibited from doing business with the public sector for a period not less than five years and not more than 10 years. The National Treasury is empowered to determine the period of restriction and each case will be dealt with on its own merits. According to section 32 of the Act the Register must be open to the public. The Register can be perused on the National Treasury website.

#### **24. Anti-dumping and countervailing duties and rights**

24.1 When, after the date of bid, provisional payments are required, or anti-dumping or countervailing duties are imposed, or the amount of a provisional payment or anti-dumping or countervailing right is increased in respect of any dumped or subsidized import, the State is not liable for any amount so required or imposed, or for the amount of any such increase. When, after the said date, such a provisional payment is no longer required or any such anti-dumping or countervailing right is abolished, or where the amount of such provisional payment or any such right is reduced, any such favourable difference shall on demand be paid forthwith by the contractor to the State or the State may deduct such amounts from moneys (if any) which may otherwise be due to the contractor in regard to supplies or services which he delivered or rendered, or is to deliver or render in terms of the contract or any other contract or any other amount which

may be due to him

**25. Force Majeure**

- 25.1 Notwithstanding the provisions of GCC Clauses 22 and 23, the supplier shall not be liable for forfeiture of its performance security, damages, or termination for default if and to the extent that his delay in performance or other failure to perform his obligations under the contract is the result of an event of force majeure.
- 25.2 If a force majeure situation arises, the supplier shall promptly notify the purchaser in writing of such condition and the cause thereof. Unless otherwise directed by the purchaser in writing, the supplier shall continue to perform its obligations under the contract as far as is reasonably practical, and shall seek all reasonable alternative means for performance not prevented by the force majeure event.

**26. Termination for insolvency**

- 26.1 The purchaser may at any time terminate the contract by giving written notice to the supplier if the supplier becomes bankrupt or otherwise insolvent. In this event, termination will be without compensation to the supplier, provided that such termination will not prejudice or affect any right of action or remedy which has accrued or will accrue thereafter to the purchaser.

**27. Settlement of Disputes**

- 27.1 If any dispute or difference of any kind whatsoever arises between the purchaser and the supplier in connection with or arising out of the contract, the parties shall make every effort to resolve amicably such dispute or difference by mutual consultation.
- 27.2 If, after thirty (30) days, the parties have failed to resolve their dispute or difference by such mutual consultation, then either the purchaser or the supplier may give notice to the other party of his intention to commence with mediation. No mediation in respect of this matter may be commenced unless such notice is given to the other party.
- 27.3 Should it not be possible to settle a dispute by means of mediation, it may be settled in a South African court of law.
- 27.4 Mediation proceedings shall be conducted in accordance with the rules of procedure specified in the SCC.
- 27.5 Notwithstanding any reference to mediation and/or court proceedings herein,
- (a) the parties shall continue to perform their respective obligations under the contract unless they otherwise agree; and
  - (b) the purchaser shall pay the supplier any monies due the supplier.

**28. Limitation of liability**

- 28.1 Except in cases of criminal negligence or willful misconduct, and in the case of infringement pursuant to Clause 6;
- (a) the supplier shall not be liable to the purchaser, whether in contract, tort, or otherwise, for any indirect or consequential loss or damage, loss of use, loss of production, or loss of profits or interest costs, provided that this exclusion shall not apply to any obligation of the supplier to pay penalties and/or damages to the purchaser; and

- (b) the aggregate liability of the supplier to the purchaser, whether under the contract, in tort or otherwise, shall not exceed the total contract price, provided that this limitation shall not apply to the cost of repairing or replacing defective equipment.
- 29. Governing language** 29.1 The contract shall be written in English. All correspondence and other documents pertaining to the contract that is exchanged by the parties shall also be written in English.
- 30. Applicable law** 30.1 The contract shall be interpreted in accordance with South African laws, unless otherwise specified in SCC.
- 31. Notices** 31.1 Every written acceptance of a bid shall be posted to the supplier concerned by registered or certified mail and any other notice to him shall be posted by ordinary mail to the address furnished in his bid or to the address notified later by him in writing and such posting shall be deemed to be proper service of such notice
- 31.2 The time mentioned in the contract documents for performing any act after such aforesaid notice has been given, shall be reckoned from the date of posting of such notice.
- 32. Taxes and duties** 32.1 A foreign supplier shall be entirely responsible for all taxes, stamp duties, license fees, and other such levies imposed outside the purchaser's country.
- 32.2 A local supplier shall be entirely responsible for all taxes, duties, license fees, etc., incurred until delivery of the contracted goods to the purchaser.
- 32.3 No contract shall be concluded with any bidder whose tax matters are not in order. Prior to the award of a bid the Department must be in possession of a tax clearance certificate, submitted by the bidder. This certificate must be an original issued by the South African Revenue Services.
- 33. National Industrial Participation Programme (NIP)** 33.1 The NIP Programme administered by the Department of Trade and Industry shall be applicable to all contracts that are subject to the NIP obligation.
- 34 Prohibition of Restrictive practices** 34.1 In terms of section 4 (1) (b) (iii) of the Competition Act No. 89 of 1998, as amended, an agreement between, or concerted practice by, firms, or a decision by an association of firms, is prohibited if it is between parties in a horizontal relationship and if a bidder (s) is / are or a contractor(s) was / were involved in collusive bidding (or bid rigging).
- 34.2 If a bidder(s) or contractor(s), based on reasonable grounds or evidence obtained by the purchaser, has / have engaged in the restrictive practice referred to above, the purchaser may refer the matter to the Competition Commission for investigation and possible imposition of administrative penalties as contemplated in the Competition Act No. 89 of 1998.

- 34.3 If a bidder(s) or contractor(s), has / have been found guilty by the Competition Commission of the restrictive practice referred to above, the purchaser may, in addition and without prejudice to any other remedy provided for, invalidate the bid(s) for such item(s) offered, and / or terminate the contract in whole or part, and / or restrict the bidder(s) or contractor(s) from conducting business with the public sector for a period not exceeding ten (10) years and / or claim damages from the bidder(s) or contractor(s) concerned.